

30×30×10mm

DC Axial-Flow Fan

★ General Specification(一般规格)

☆ Material: Frame And Impeller: Thermal Plastic UL 94V-0

☆ Lead Wires: UL Type

RED Wire Positive(+)

BLACK Wire Negative(-)

☆ Insulation Resistance: 10MΩ Or Over With a DC250V Megger

☆ Dielectric Withstand Voltage: AC500V 1S

☆ Allowable Ambient Temperature Range:

-10°C ~ +70°C(Operation)

-40°C ~ +70°C(Storage)

★ Dimensions Drawing(外观图)

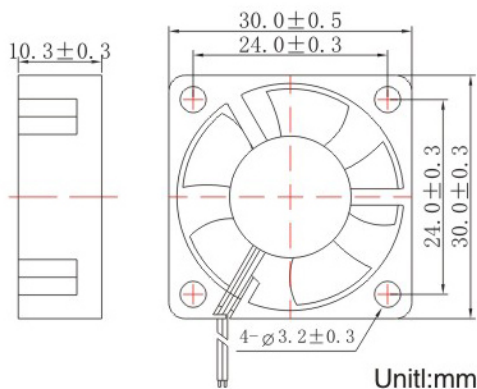

★ Characteristic Curves(特性曲线)

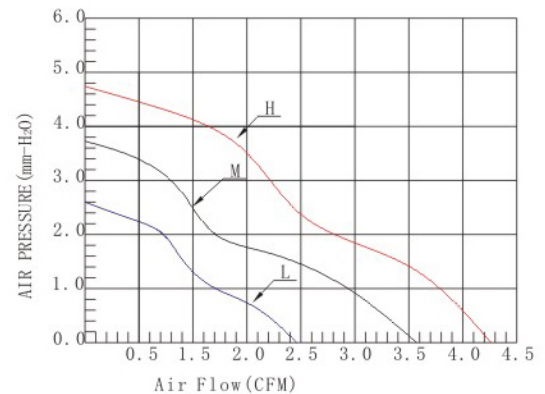

★ Specifications(规格)

Model (型号)	Bearing System (培林)	Rated Voltage (V) (电压)	Operation Voltage (V) (电压范围)	Current (A) (电流)	Input power (W) (功率)	Speed (RPM) (转速)	Air Flow (CFM) (风量)	Static Pressure (mm-H ₂ O) (静压)	Noise Level (dB-A) (噪音)	Weight (g) (重量)
YD053010HS	Sleeve	5	4.5~5.5	0.20	1.00	9500	4.23	4.47	28.46	8
YD053010MS				0.16	0.80	8000	3.56	3.76	23.23	8
YD053010LS				0.14	0.70	5500	2.45	2.59	20.26	8
YD053010HB	Ball			0.20	1.00	9500	4.23	4.47	28.46	8
YD053010MB				0.16	0.80	8000	3.56	3.76	23.23	8
YD053010LB				0.14	0.70	5500	2.45	2.59	20.26	8
YD123010HS	Sleeve	12	10.8~13.2	0.12	1.44	9500	4.23	4.47	28.46	8
YD123010MS				0.10	1.2	8000	3.56	3.76	23.23	8
YD123010LS				0.08	0.96	5500	2.45	2.59	20.26	8
YD123010HB	Ball			0.12	1.44	9500	4.23	4.47	28.46	8
YD123010MB				0.10	1.2	8000	3.56	3.76	23.23	8
YD123010LB				0.08	0.96	5500	2.45	2.59	20.26	8