

DC Axial-Flow Fan



25×25×10mm

★ General Specification(一般规格)

☆ Material: Frame And Impeller: Thermal Plastic UL 94V-0

☆ Lead Wires: UL Type

RED Wire Positive(+)

BLACK Wire Negative(-)

☆ Insulation Resistance: 10MΩ Or Over With a DC250V Megger

☆ Dielectric Withstand Voltage: AC500V 1S

☆ Allowable Ambient Temperature Range:

-10°C ~ +70°C(Operation)

-40°C ~ +70°C(Storage)

★ Dimensions Drawing(外观图)

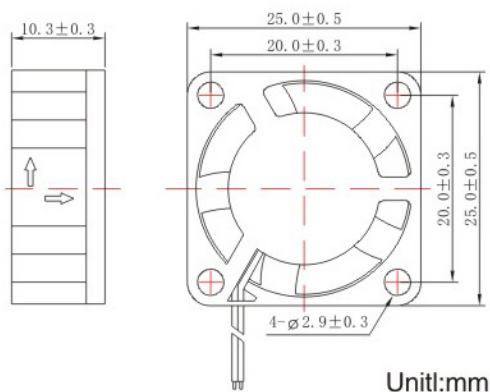

★ Characteristic Curves(特性曲线)

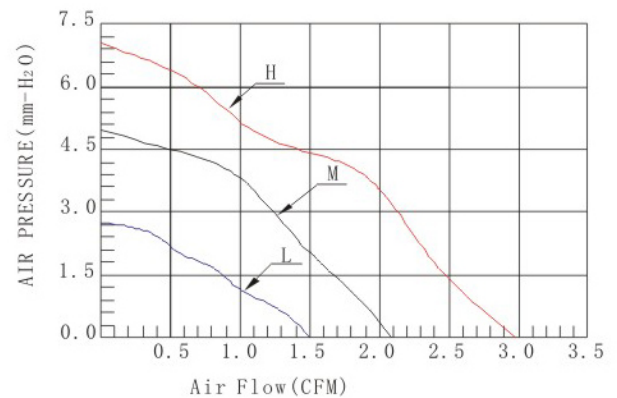

★ Specifications(规格)

Model (型号)	Bearing System (培林)	Rated Voltage (V) (电压)	Operation Voltage (V) (电压范围)	Current (A) (电流)	Input power (W) (功率)	Speed (RPM) (转速)	Air Flow (CFM) (风量)	Static Pressure (mm-H ₂ O) (静压)	Noise Level (dB-A) (噪音)	Weight (g) (重量)
YD052510HS	Sleeve	5	4.5~5.5	0.20	1.00	13000	2.90	6.93	30.78	6
YD052510MS				0.16	0.80	10000	2.22	5.01	24.11	6
YD052510LS				0.14	0.70	7000	1.53	2.40	18.97	6
YD052510HB	Ball			0.20	1.00	13000	2.90	6.93	30.78	6
YD052510MB				0.16	0.80	10000	2.22	5.01	24.11	6
YD052510LB				0.14	0.70	7000	1.53	2.40	18.97	6
YD122510HS	Sleeve	12	10.8~13.2	0.12	1.44	13000	2.90	6.93	30.78	6
YD122510MS				0.10	1.20	10000	2.22	5.01	24.11	6
YD122510LS				0.08	0.96	7000	1.53	2.40	18.97	6
YD122510HB	Ball			0.12	1.44	13000	2.90	6.93	30.78	6
YD122510MB				0.10	1.2	10000	2.22	5.01	24.11	6
YD122510LB				0.08	0.96	7000	1.53	2.40	18.97	6