

60×60×25mm

DC Axial-Flow Fan

★ General Specification(一般规格)

☆ Material: Frame And Impeller: Thermal Plastic UL 94V-0

☆ Lead Wires: UL Type

RED Wire Positive(+)

BLACK Wire Negative(-)

☆ Insulation Resistance: 10MΩ Or Over With a DC250V Megger

☆ Dielectric Withstand Voltage: AC500V 1S

☆ Allowable Ambient Temperature Range:

-10°C ~ +70°C(Operation)

-40°C ~ +70°C(Storage)

★ Dimensions Drawing(外观图)

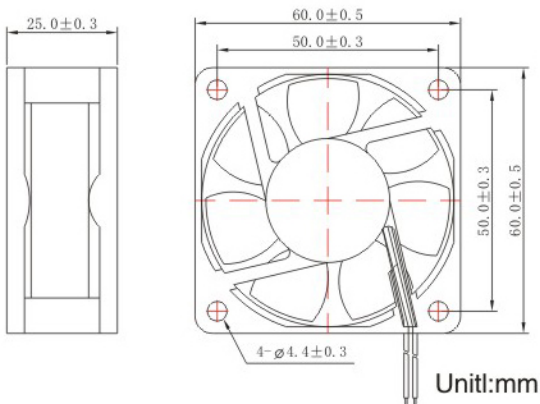

★ Characteristic Curves(特性曲线)

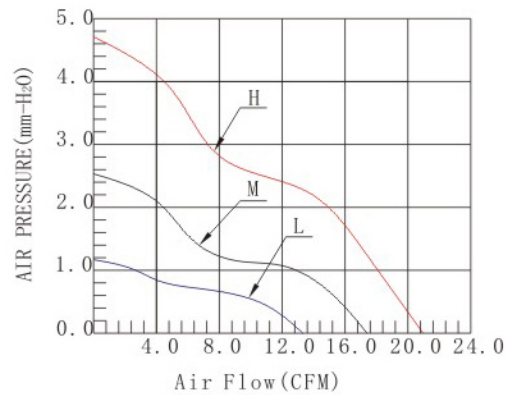

★ Specifications(规格)

Model (型号)	Bearing System (培林)	Rated Voltage (V) (电压)	Operation Voltage (V) (电压范围)	Current (A) (电流)	Input power (W) (功率)	Speed (RPM) (转速)	Air Flow (CFM) (风量)	Static Pressure (mm-H ₂ O) (静压)	Noise Level (dB-A) (噪音)	Weight (g) (重量)
YD126025HS	Sleeve	12	10.8~13.2	0.14	1.68	4000	21.08	4.70	29.32	60
YD126025MS				0.11	1.32	3300	17.41	2.56	24.64	60
YD126025LS				0.08	0.96	2500	13.21	1.15	21.05	60
YD126025HB	Ball			0.14	1.68	4000	21.08	4.70	29.32	60
YD126025MB				0.11	1.32	3300	17.41	2.56	24.64	60
YD126025LB				0.08	0.96	2500	13.21	1.15	21.05	60
YD246025HS	Sleeve	24	21.6~26.4	0.10	2.40	4000	21.08	4.70	29.32	60
YD246025MS				0.08	1.92	3300	17.41	2.56	24.64	60
YD246025LS				0.06	1.44	2500	13.21	1.15	21.05	60
YD246025HB	Ball			0.10	2.40	4000	21.08	4.70	29.32	60
YD246025MB				0.08	1.92	3300	17.41	2.56	24.64	60
YD246025LB				0.06	1.44	2500	13.21	1.15	21.05	60