

DC Axial-Flow Fan



60×60×20mm

★ General Specification(一般规格)

- ☆ Material: Frame And Impeller: Thermal Plastic UL 94V-0
- ☆ Lead Wires: UL Type
 - RED Wire Positive(+)
 - BLACK Wire Negative(-)
- ☆ Insulation Resistance: 10MΩ Or Over With a DC250V Megger
- ☆ Dielectric Withstand Voltage: AC500V 1S
- ☆ Allowable Ambient Temperature Range:
 - 10°C ~ +70°C (Operation)
 - 40°C ~ +70°C (Storage)

★ Dimensions Drawing(外观图)

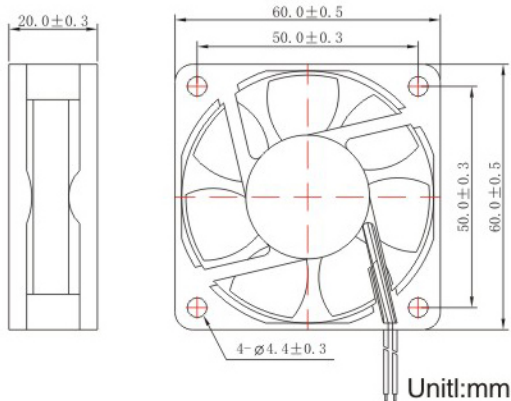

★ Characteristic Curves(特性曲线)

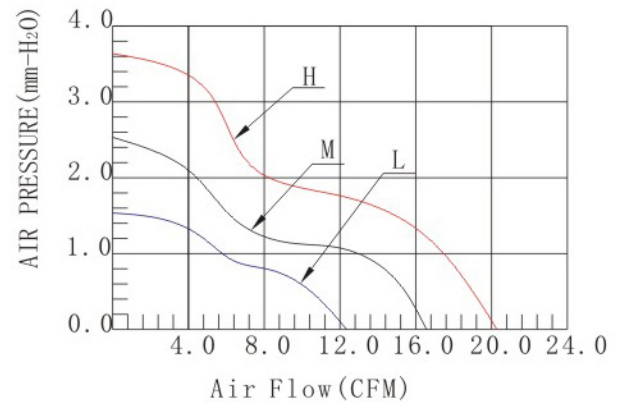

★ Specifications(规格)

Model (型号)	Bearing System (培林)	Rated Voltage (V) (电压)	Operation Voltage (V) (电压范围)	Current (A) (电流)	Input power (W) (功率)	Speed (RPM) (转速)	Air Flow (CFM) (风量)	Static Pressure (mm-H ₂ O) (静压)	Noise Level (dB-A) (噪音)	Weight (g) (重量)
YD126020HS	Sleeve	5	4.5~5.5	0.15	1.80	4000	20.28	3.65	29.04	49
YD126020MS				0.10	1.20	3300	16.50	2.50	23.85	49
YD126020LS				0.07	0.84	2500	12.31	1.45	21.35	49
YD126020HB	Ball			0.15	1.80	4000	20.28	3.65	29.04	49
YD126020MB				0.10	1.20	3300	16.50	2.50	23.85	49
YD126020LB				0.07	0.84	2500	12.31	1.45	21.35	49
YD246020HS	Sleeve	12	10.8~13.2	0.12	2.88	4000	20.28	3.65	29.04	49
YD246020MS				0.08	1.92	3300	16.50	2.50	23.85	49
YD246020LS				0.05	1.20	2500	12.31	1.45	21.35	49
YD246020HB	Ball			0.15	2.88	4000	20.28	3.65	29.04	49
YD246020MB				0.13	1.92	3300	16.50	2.50	23.85	49
YD246020LB				0.11	1.20	2500	12.31	1.45	21.35	49