



60×60×15mm

DC Axial-Flow Fan

★ General Specification(一般规格)

☆ Material: Frame And Impeller: Thermal Plastic UL 94V-0

☆ Lead Wires: UL Type

RED Wire Positive(+)

BLACK Wire Negative(-)

☆ Insulation Resistance: 10MΩ Or Over With a DC250V Megger

☆ Dielectric Withstand Voltage: AC500V 1S

☆ Allowable Ambient Temperature Range:

-10°C ~ +70°C(Operation)

-40°C ~ +70°C(Storage)

★ Dimensions Drawing(外观图)

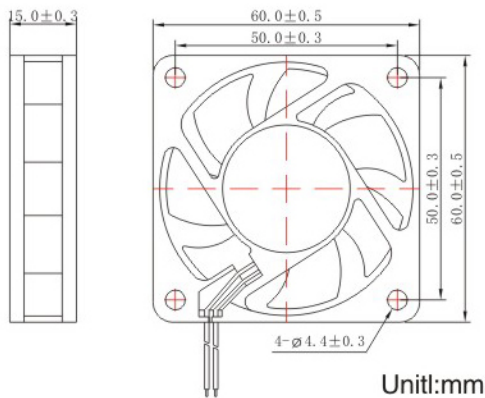

★ Characteristic Curves(特性曲线)

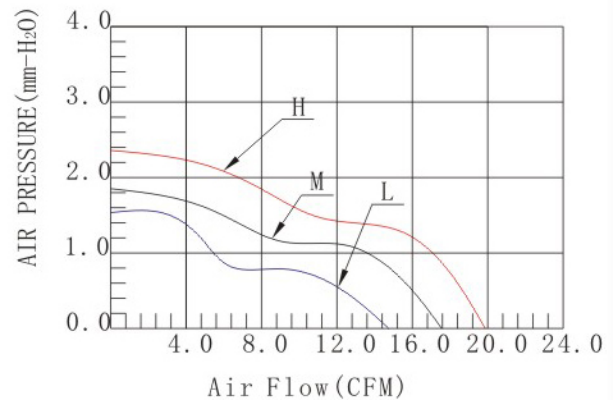

★ Specifications(规格)

Model (型号)	Bearing System (培林)	Rated Voltage (V) (电压)	Operation Voltage (V) (电压范围)	Current (A) (电流)	Input power (W) (功率)	Speed (RPM) (转速)	Air Flow (CFM) (风量)	Static Pressure (mm-H ₂ O) (静压)	Noise Level (dB-A) (噪音)	Weight (g) (重量)
YD056015HS	Sleeve	5	4.5~5.5	0.26	1.30	4000	19.83	2.35	34.63	33
YD056015MS				0.20	1.00	3500	17.58	1.85	30.69	33
YD056015LS				0.14	0.70	3000	14.67	1.27	28.54	33
YD056015HB	Ball			0.26	1.30	4000	19.83	2.35	34.63	33
YD056015MB				0.20	1.00	3500	17.58	1.85	30.69	33
YD056015LB				0.14	0.70	3000	14.67	1.27	28.54	33
YD126015HS	Sleeve	12	10.8~13.2	0.15	1.80	4000	19.83	2.35	34.63	33
YD126015MS				0.13	1.56	3500	17.58	1.85	30.69	33
YD126015LS				0.11	1.32	3000	14.67	1.27	28.54	33
YD126015HB	Ball			0.15	1.80	4000	19.83	2.35	34.63	33
YD126015MB				0.13	1.56	3500	17.58	1.85	30.69	33
YD126015LB				0.11	1.32	3000	14.67	1.27	28.54	33